

Article number: 20534560M12E

Description: E+G Three-star knobs - GN 5345-60-M12-E

Measures

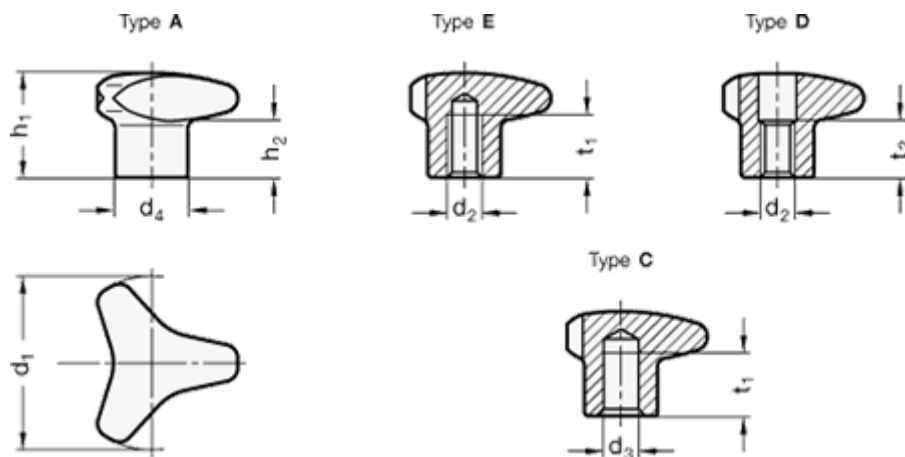

d1 = 60
d2 = M12
d3 H7 = -
d4 = -
h1 = 35
h2 = 18
t1 min. = 22
t2 = -

Weight (g) = 232